

QUICK INSTALLATION GUIDE

OVERVIEW

DC Connectors (+) For PV Strings
DC Switch

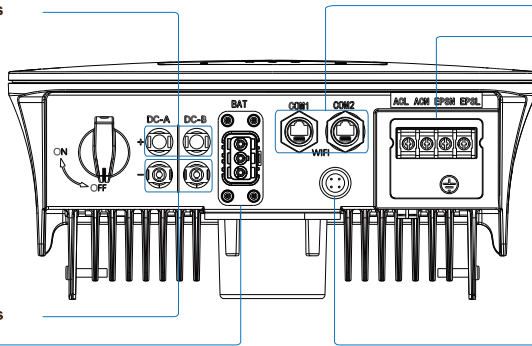

DC Connectors (-) For PV Strings
Battery Port

Communication Port
AC Port & EPS Port

Monitor Module Port

PACKAGE LIST

Please check to make sure the packing and all components are not missing or damaged. Please contact your dealer directly for supports if there is any damage or missing components.

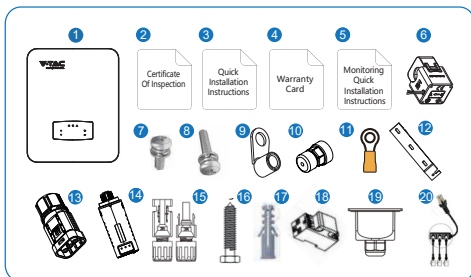

No.	Qty	Items	No.	Qty	Items
1	1	Hybrid Inverter	11	1	Grounding Terminal
2	1	Certificate Of Inspection	12	1	Wall Mounting Bracket
3	1	Quick Installation Instructions	13	1	Battery Connector
4	1	Warranty Card	14	1	Monitor Module
5	1	Monitoring Quick Installation Instructions	15	1/2	DC Connector
6	1	CT	16	3	Mounting Bracket Screw
7	4	AC Wiring Cover Screw	17	3	Plastic Expansion Tube
8	1	Security Screw	18	1	Smart Meter (Optional)
9	4	AC Wiring Terminal	19	1	AC Waterproof Cover
10	2	Communication Connectors	20	1	RJ45 Connector/ Communication Adaptor

FOR ENQUIRIES PLEASE CONTACT V-TAC'S AFTERCARE TEAM

customer@vtacexports.com

+44 2072991212

+447418377888

OPERATING HOURS : 8:30AM TO 5:30PM MONDAY - FRIDAY | 10:00AM TO 2:00PM ON SATURDAYS

MOUNTING

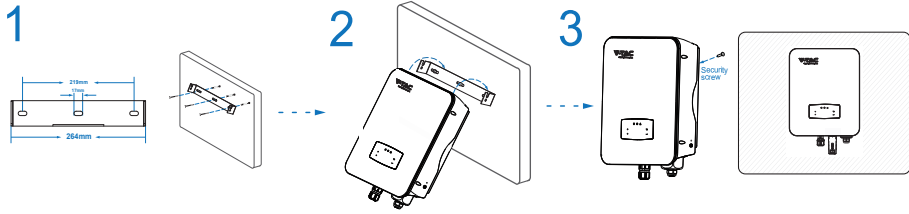

PV CONNECTION

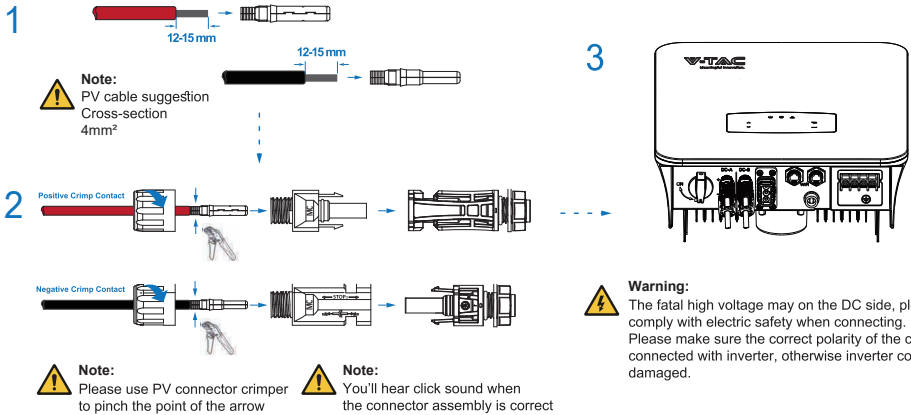

BATTERY CONNECTION

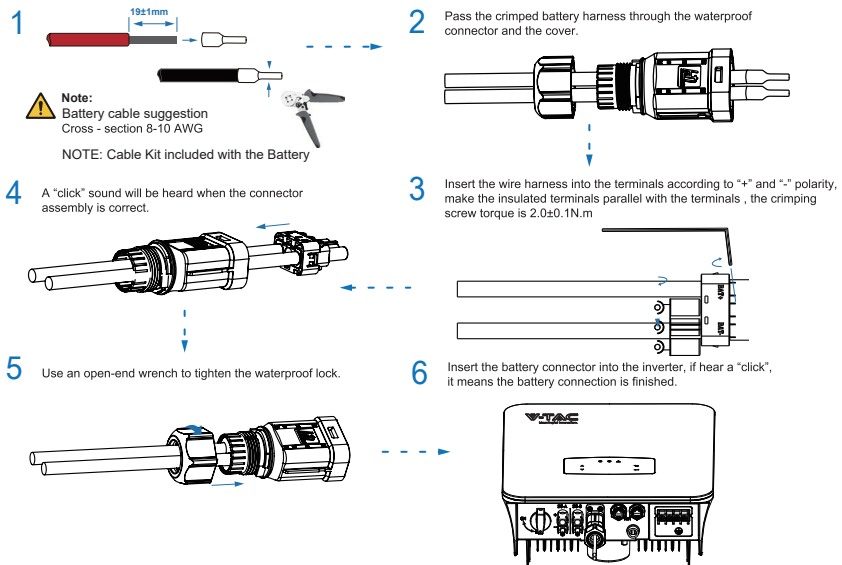

FOR ENQUIRIES PLEASE CONTACT V-TAC'S AFTERCARE TEAM

customer@vtacexports.com +44 2072991212 +447418377888

OPERATING HOURS : 8:30AM TO 5:30PM MONDAY - FRIDAY | 10:00AM TO 2:00PM ON SATURDAYS

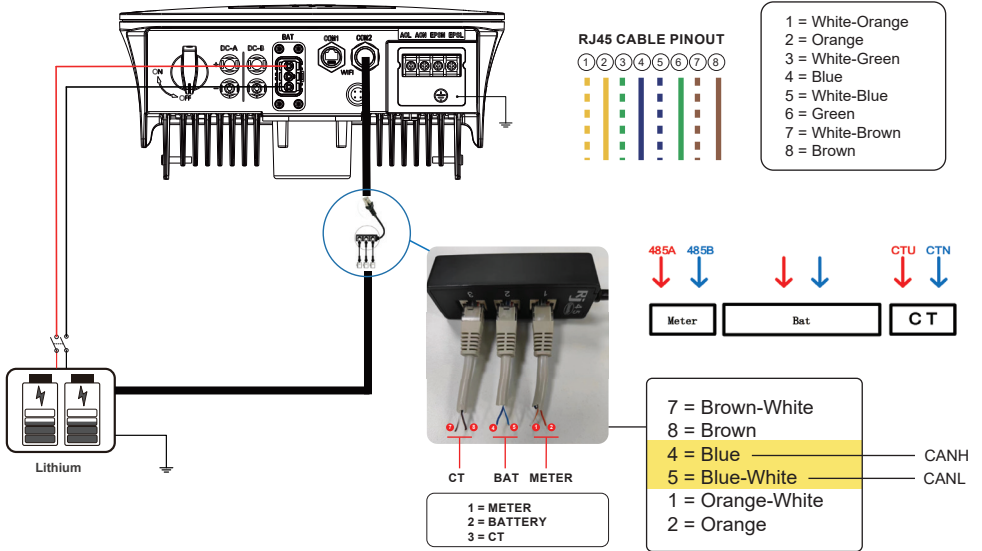

GRID AND EPS CONNETION

1

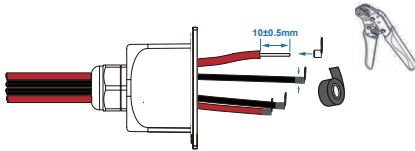

2

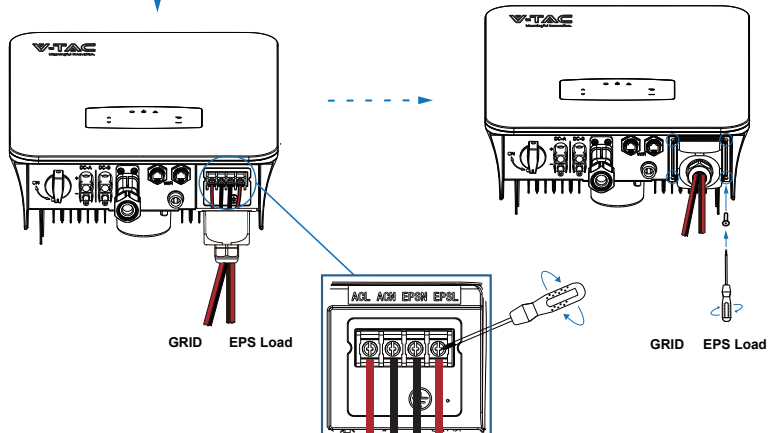

- Note:**
Cable suggestion Cross-section 8-10AWG.
- Note:**
The Max. power load connects to EPS port should not exceed the inverter's EPS Max. output power range.
- Note:**
The wiring terminals should be wrapped with insulation tape, otherwise it will cause a short circuit and damage the inverter.

FOR ENQUIRIES PLEASE CONTACT V-TAC'S AFTERCARE TEAM

customer@vtacexports.com +44 2072991212 +447418377888

OPERATING HOURS : 8:30AM TO 5:30PM MONDAY - FRIDAY | 10:00AM TO 2:00PM ON SATURDAYS

CT OR METER CONNETION

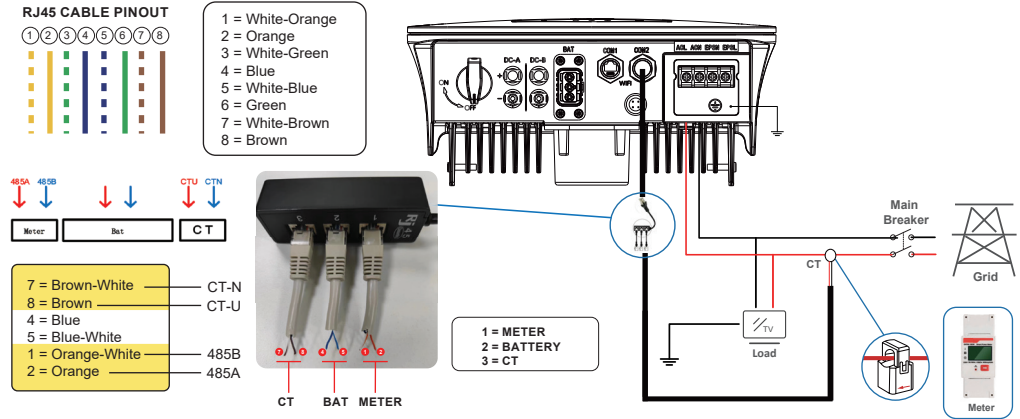

WIFI CONNECTION

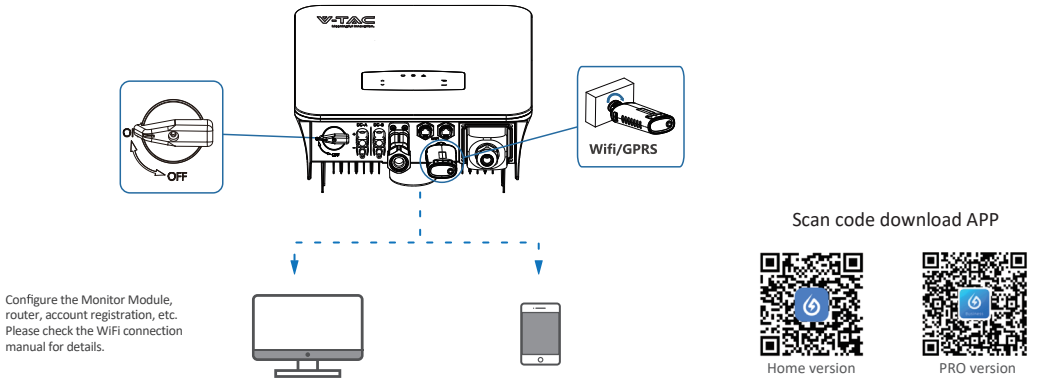

GROUND CONNECTION

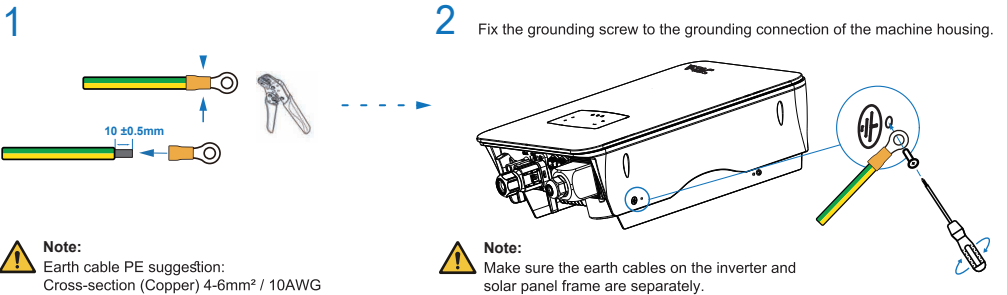

FOR ENQUIRIES PLEASE CONTACT V-TAC'S AFTERCARE TEAM

customercare@vtacexports.com +44 2072991212 +447418377888

OPERATING HOURS : 8:30AM TO 5:30PM MONDAY - FRIDAY | 10:00AM TO 2:00PM ON SATURDAYS

BATTERY COMMISSIONING

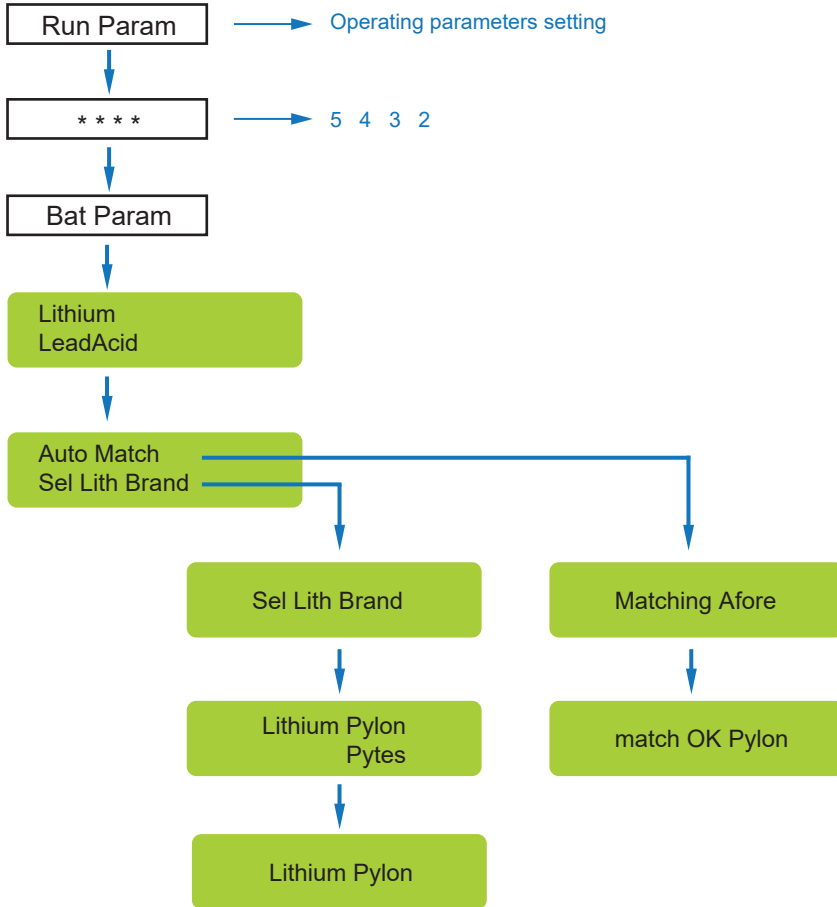

FOR ENQUIRIES PLEASE CONTACT V-TAC'S AFTERCARE TEAM

customercare@vtacexports.com

+44 2072991212

+447418377888

OPERATING HOURS : 8:30AM TO 5:30PM MONDAY - FRIDAY | 10:00AM TO 2:00PM ON SATURDAYS

INVERTER TO BATTERY COMMUNICATION

BATTERY SKUs : 11524, 11525

NOTE: Cable Kit included with the Battery

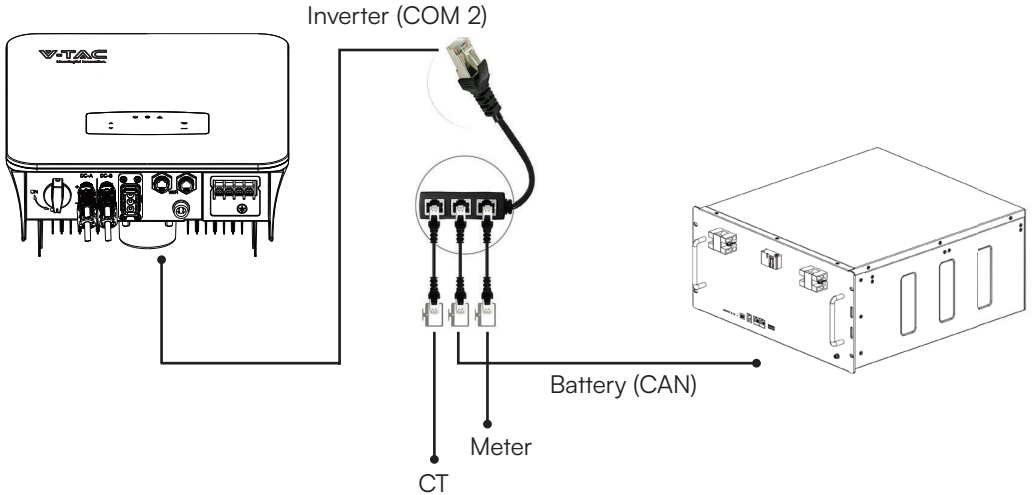

PIN CONFIGURATION

INVERTER : PIN Configuration (COM 2)

No.	COM1	COM2
1	NTC+	Meter 485A
2	NTC-	Meter 485B
3	Dry Contact	BAT 485A
4	Dry Contact	BAT CANH
5	DRM	BAT CANL
6	DRM	BAT 485B
7	485A	CTU
8	485B	CTN

BATTERY : PIN Configuration (CAN)

PIN	Description
1	RS485_B
2	RS485_A
3	CANO-H (communicate with the next battery)
4	CAN1-H (communicate with inverter)
5	CAN1-L (communicate with inverter)
6	GND_RS485
7	CANO-L (communicate with the next battery)
8	/

FOR ENQUIRIES PLEASE CONTACT V-TAC'S AFTERCARE TEAM

customer@vtacexports.com

+44 2072991212

+447418377888

OPERATING HOURS : 8:30AM TO 5:30PM MONDAY - FRIDAY | 10:00AM TO 2:00PM ON SATURDAYS

INVERTER TO BATTERY COMMUNICATION

BATTERY SKUs : 11377, 11523, 11526

NOTE: Cable Kit included with the Battery

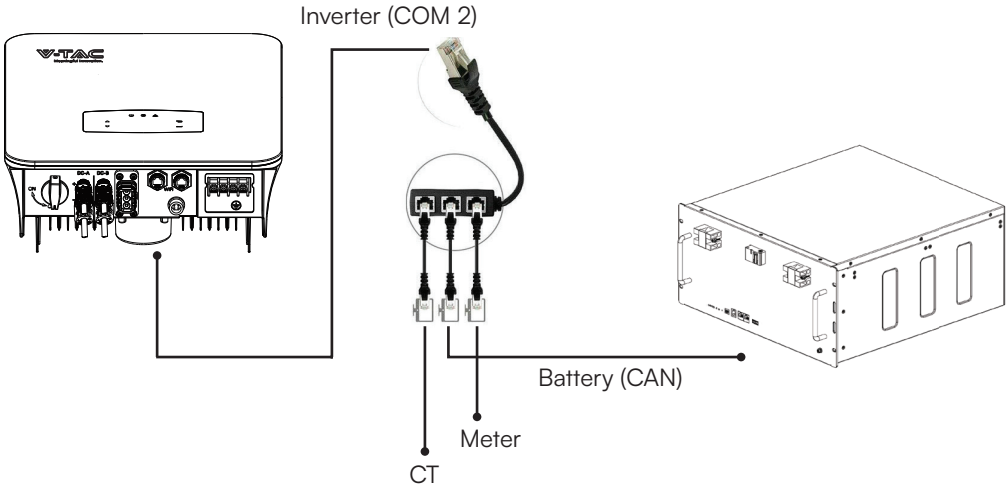

PIN CONFIGURATION

Inverter PIN Configuration (COM 2)

No.	COM1	COM2
1	NTC+	Meter 485A
2	NTC-	Meter 485B
3	Dry Contact	BAT 485A
4	Dry Contact	BAT CANH
5	DRM	BAT CANL
6	DRM	BAT 485B
7	485A	CTU
8	485B	CTN

Battery PIN Configuration (CAN)

PIN	Description
1/2/3	NC
4	RS485_A
5	CAN_L
6	CAN_H
7	RS485_B
8	GND

FOR ENQUIRIES PLEASE CONTACT V-TAC'S AFTERCARE TEAM

customer@vtacexports.com

+44 2072991212

+447418377888

OPERATING HOURS : 8:30AM TO 5:30PM MONDAY - FRIDAY | 10:00AM TO 2:00PM ON SATURDAYS