

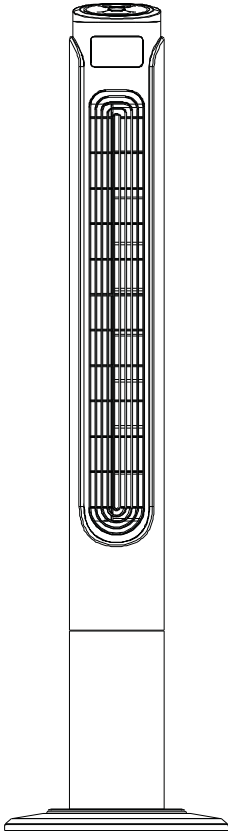

WEEE Number: 80133970

INSTALLATION INSTRUCTION

LED DISPLAY TOWER FAN



SPECIFICATIONS

MODEL NO:	VT-5546
SPEED:	3 (Low , Medium & High)
Wind Mode:	3 (Normal / Natural / Sleep)
Size:	46" Inch
Power:	55W
Timer:	1-15Hours (Max)
Voltage:	AC: 220-240V, 50Hz
Power Cord length:	1.75 meters
Plug Type:	EU plug
Color:	Black Finish
Protection Rating:	IP20
Material:	ABS

INTRODUCTION

Thank you for selecting and buying V-TAC product. V-TAC will serve you the best. Please read these instructions carefully before starting the installing and keep this manual handy for future reference. If you have any another query, please contact our dealer or local vendor from whom you have purchased the product. They are trained and ready to serve you at the best.



Safety Instructions & Warning

- 1) For INDOOR USE ONLY. Always operate the product from a power source of the same voltage, frequency rating as indication on the product label.
- 2) Remove the unit from its packing and check all parts to make sure the product is in good condition before.
- 3) Do not operate the product with damaged cord or plug, or malfunctioned product or if damaged. Before unplugging the power cord, be sure to Turn the Power OFF. Do not touch the product with Wet Hands.
- 4) Never install the unit where it is exposed to direct sunlight/excessive moisture/rain/dust/lack of ventilation/near Heat sources.
- 5) DO NOT MAKE CONTACT WITH MOVING PARTS of the fan when it is POWERED ON.
- 6) Always place the Fan on stable, level surface when operating to prevent the fan from overturning.
- 7) Do not run the cord under the carpet. Do not cover the power cord with throw rugs or runners. Connect the power cord away from walking path. The power chord should be kept away from heat, sharp edges & oil.
- 8) Switch OFF and unplug the power chord from outlet when not in use, before assembling or disassembling part or before cleaning. Make sure no other high current appliance is plugged into the same circuit as your fan, as an overload can occur.

Parts Identification

Main Unit

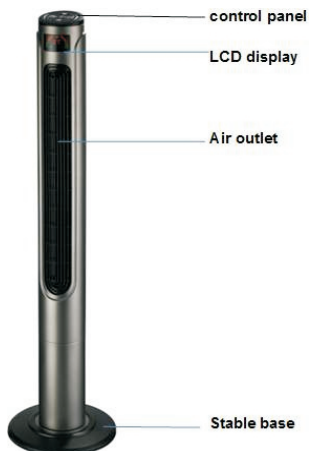

Control Panel / Remote Control





Assembly Instruction

ASSEMBLING

1. Remove the parts from packing.
2. Fix the two parts of base together.
3. Pass the power cord through the centre of hole of the base, after fixing the two pieces together.
4. Line up the fan on the base, and fix with base lock.

No screw(s) is(are) needed to lock the base.

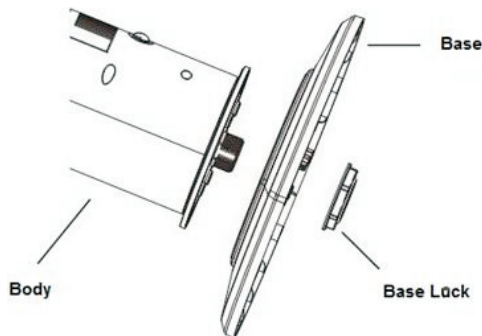

Operating Instruction

NOTE: Before inserting the plug into a power outlet, make sure that the correct voltage is being used which corresponds to the information which is indicated on the rating label, and that the socket has an earth facility.

Caution: Fan must be assembled with the base before use!

Fan can be operated by the control panel located on top of the Fan or by remote control.

1. Place the Fan on a stable and flat surface. Plug the Power Cord into an AC:220-240V electrical outlet. The LED screen will display the current room temperature.

2. **POWER:** Turn the Fan ON by pressing the  button, the Fan will start at low speed.

3. **SPEED:** Adjust the Fan speed to the desired level from Low to Medium to high by

pressing the  button. The speed setting is displayed on the LED screen.

4. **MODE:** Press the MODE button to set the Fan as Normal, Natural or Sleep mode. The mode is displayed on the LED screen. **a) Normal mode:** Speed is constant.

b) Natural mode: Fan speed varies, mimicking natural wind blowing.

c) Sleep mode: Fan speed slows down over time from the original set speed.

As the mode is adjusted, the display cycles through the different icons.

5. **OSC:** Press the  button to allow the Fan to oscillate from left to right. To stop the oscillation, press the oscillation button again.



6. TIMER: Press the TIMER  button to set desired auto power-off time. Designed with 15 time intervals from 1-hour to 15-hour.

7. Power Saving Mode: When the 'Sleep' mode or the 'Timer' is on, the main display will be off after 30 seconds, and you can press any keys to turn on the display again.

8. Unplug the Fan when not in use.

Remote Control Instructions:

- 1) Insert the round button shape battery (included in the product) into the back of the remote control.
- 2) The remote controls is designed with all the functions same as the base unit. Follow the same instructions above to operate the fan remotely.
- 3) Please remove the battery from the remote control if it is not in use for long time.

Care & Cleaning

Note: If the power cord set of this appliance becomes damaged, discontinue use. Repairs should be undertaken by qualified technician ONLY.

- 1) Always Switch Power OFF and then unplug power chord before cleaning.
- 2) Clean the housing with a damp cloth, a vacuum cleaner or a dusting brush.
- 3) We recommend lightly running a vacuum cleaner brush nozzle over the fan grill to remove any dust or dirt that may have accumulated.
- 4) Never use flammable or abrasive cleaning agents such as benzene or spirits to clean the appliance.
- 5) Never immerse the appliance in water or rinse under the tap.