



Meaningful Innovation.

WEEE Number: 80133970

INSTRUCTION MANUAL

5.12kWh WALL MOUNTED
LITHIUM BATTERY



MODEL	SKU
VT-48100-W2	11524

**IP65
RATING**

**05 YEAR
WARRANTY***

INTRODUCTION

Thank you for selecting and buying V-TAC Product. V-TAC will serve you the best. Please read these instructions carefully & keep this user manual handy for future reference. If you have any another query, please contact our dealer or local vendor from whom you have purchased the product. They are trained and ready to serve you at the best.

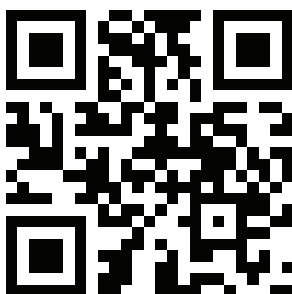

MULTI-LANGUAGE MANUAL QR CODE

Please scan the QR code to access the manual in multiple languages.

About This Document

Purpose

This document primarily introduces the main features, component composition, usage, installation, and maintenance of V-Power Wall-mounted Residential Energy Storage System VE51100W (short for V-Power S05).





Intended Audience

This document is intended for:

- Hardware installation engineers
- Technical support engineers
- Maintenance engineers
- Users

Symbol Conventions

The symbols that may be found in this document are defined as follows.

Symbol	Definition	Remarks
	Danger	Indicates a hazard with a high level of risk which, if not avoided, will result in death or serious injury.
	Warning	Indicates a hazard with a medium level of risk which, if not avoided, could result in death or serious injury.
	Attention	Indicates a hazard with a low level of risk which, if not avoided, could result in minor or moderate injury.
 NOTE	Note	Supplements the important information in the main text. NOTE is used to address information not related to personal injury, equipment damage, and environmental deterioration.

Change History

Changes between the issued documents are cumulative. The latest document issued contains all the changes made in earlier versions.

Issue 01 (2023-01-31)

This issue is the first official release.

Contents

About This Document	1
1 Introduction	3
1.1 Application	3
1.2 Appearance	3
1.3 Panel Introduction.....	4
1.4 PIN Definition	6
1.5 Lithium-ion Cell	7
1.6 Technical specifications	8
2 Installation	10
2.1 Precautions for Installation	10
2.2 Preparing for Installation.....	10
2.2.1 Tools.....	10
2.2.2 Packing List.....	11
2.2.3 Unpacking Acceptance.....	12
2.3 Installing Guide.....	12
2.4 Connecting Power Cable	14
2.5 Connecting Communication Cable.....	17
3 Operation	19
3.1 Check before Power-on	19
3.2 Power-on	19
3.3 Operation Guide.....	20
4 Maintenance	22
4.1 V-Power S05 Storage	22
4.2 Monthly Maintenance.....	22
4.3 Quarterly Maintenance	23
4.4 Yearly Maintenance.....	23
4.5 Alarm Handling.....	23
Acronyms and Abbreviations.....	25

1 Introduction

1.1 Application

V-Power S05 is a next-generation product developed by VTAC, which is used in residential energy storage solutions. This battery system has a capacity of 5.12 kWh.

V-Power S05 integrates the high-performance BMS. It has multiple protection functions to extend battery life, such as system over-charge, system over-discharge, cell over-voltage, cell under-voltage, charging over-current, discharging over-current, and insulation fault. It also has RS485 and CAN communication to read battery module's real-time data.

1.2 Appearance

The appearance of V-Power S05 is shown as follows.



Figure 1. V-Power S05 appearance

The V-Power S05 dimensions are shown as follows:

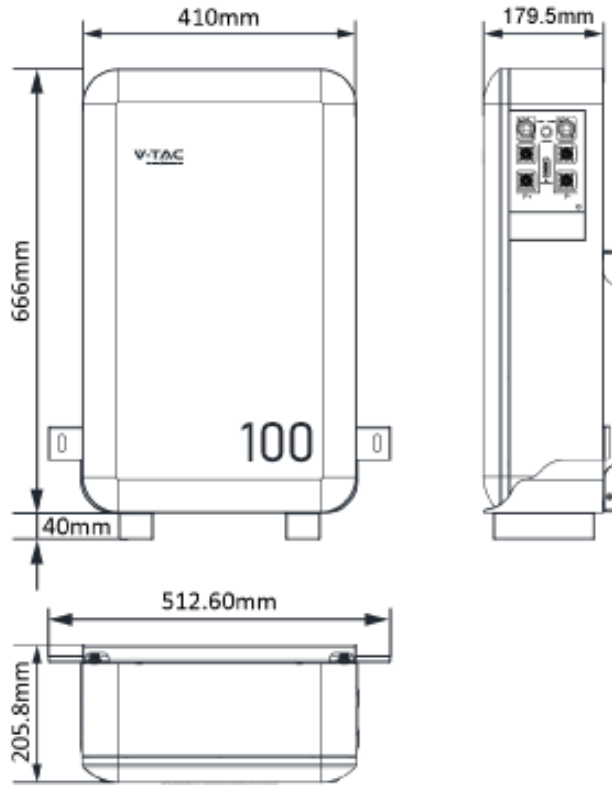

Figure 2. V-Power S05 dimensions (unit: mm)

1.3 Panel Introduction

The V-Power S05 operation panel is shown as follows.

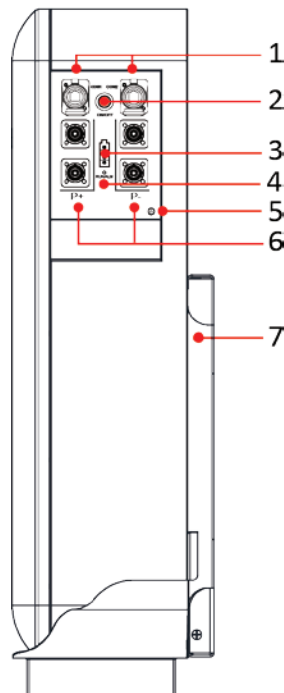

Figure 3. V-Power S05 operation panel





The definition of the V-Power S05 operation panel is shown as follows.

Table 1. Operation Panel Interface Definition

No.	Items	Remark
1	COM 1/COM 2	2*RJ45 Interface for communication: COM1 for communication with inverter or the next battery; COM2 for communication with the next battery.
2	POWER	Power Switch.
3	SOC	State of Charge.
4	RUN/ALM	Indicate battery module running or alarm status.
5	GND	Grounding.
6	Output connectors	Battery module output connectors.
7	Bracket	Mounting bracket.

The SOC indicator used to identify the current capacity status of the battery. The number of flashing indicators corresponds to different remaining capacity. The specific meaning is shown as follows.

Table 2. The SOC Indicator Definition

No.	Indicator Light	Remark
1		0% < SOC ≤ 25%
2		25% < SOC ≤ 50%
3		50% < SOC ≤ 75%
4		75% < SOC ≤ 100%

The corresponding relationship between operation status and indicator operation status is shown as follows.

Table 3. The Run/Alarm Indicator Definition

No.	Indicator Light	Definition
1	Green LED Flash	Indicates the V-Power S05 is charging or discharging.
2	Green LED ON	Indicates the V-Power S05 is in standby mode.
3	Red LED Flash	Indicates the V-Power S05 is in alarm mode.
4	Red LED ON	Indicates an error has occur in the V-Power S05, which requires manual operation or consultation with VTAC for maintenance.

1.4 PIN Definition

V-Power S05 has 2 communication interfaces: COM1 and COM2, the PIN definition of COM ports are shown as follows.

Table 4. The Communication Port Definition

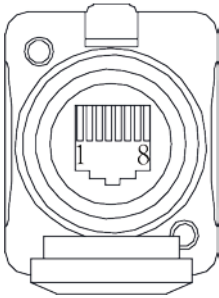
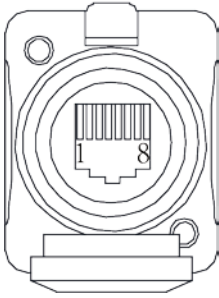
COM1/2	Pin	Description
 <p>COM 1</p>	1	RS485_B
	2	RS485_A
	3	CAN0-H (communicate with the next battery)
	4	CAN1-H (communicate with inverter)
	5	CAN1-L (communicate with inverter)
	6	GND_RS485
	7	CAN0-L (communicate with the next battery)
	8	/
 <p>COM 2</p>	1	/
	2	/
	3	CAN0-H (communicate with the next battery)
	4	/
	5	/
	6	/
	7	CAN0-L (communicate with the next battery)

	8	/
--	---	---

1.5 Lithium-ion Cell

The lithium iron phosphate cell selected in the scheme is a special energy-type lithium battery product. This series of lithium iron phosphate cells have high specific energy, longer cycle life, low cost, capable of high current charge and discharge, high-temperature tolerance, high energy density, safety, and pollution-free features.

Lithium-ion cell's three views are shown as follows.

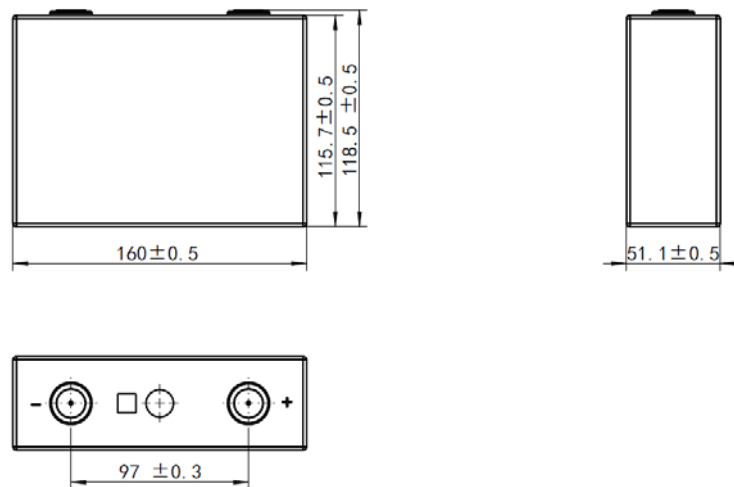

Figure 4. Lithium-ion cell three views (unit: mm)

Lithium-ion cell main technical specifications are shown as follows.

Table 5. Lithium-ion cell main technical specifications

No.	Items	Parameter
1	Battery type	LiFePO ₄
2	Rated voltage	3.2 V
3	Rated capacity	100 Ah
4	Rated energy	0.32 kWh
5	Max continuous charge current	100 A
6	Max continuous discharge current	100 A
7	Charging cut-off voltage	3.65 V
8	Discharging cut-off voltage	2.80 V

No.	Items	Parameter
9	Operating charging temperature	0°C-50°C
10	Operating discharging temperature	-20°C-55°C
11	Storage temperature	0-45°C (less than 1 month); 0-35°C (less than 12 months);
12	Operating humidity	5%-95% RH
13	Size (Width*High*Depth)	160.0 mm×115.7 mm×51.1 mm
14	Weight	Approx. 1.92 kg

1.6 Technical specifications

The V-Power S05's main technical specifications are shown as follows.

Table 6. V-Power S05 technical specifications

No.	Items	Parameter
1	Model	VE51100W
2	The number of cells	16
3	Cells in series and parallel	1P16S
4	Rated voltage	51.2 V
5	Rated capacity	100 Ah
6	Rated energy	5.12 kWh
7	Charging cut-off voltage	57.6 V
8	Discharging cut-off voltage	44.8 V
9	Max continuous charge current	100 A
10	Max continuous discharge current	100 A
11	Communication method	CAN/RS485
12	Maximum number of modules allowed to be connected in parallel	Parallel expandable, ≤ 16 groups, without derating. More than 16 groups need to be derated.
13	Storage temperature	0°C~ 45°C

No.	Items	Parameter
14	Operating temperature	Discharge -20°C ~ 55°C, Charge 0°C ~50°C
15	SOC estimation value	<8%
16	Allowable relative humidity	5% ~ 95% Non-condensing
17	Altitude	2000m without derating
18	Cooling method	Natural heat dissipation
19	Protection level	IP65
20	External Interface	Battery positive and negative quick plug terminals: 2*P+, 2*P- Communication standard RJ45 port:2*RJ45
21	Installation method	Standed/Wall-mounted
22	Display method	Indicator light (power, operation status)
23	Size (Width*High*Depth)	410.0 mm×666.2 mm×179.5 mm (without wall bracket and base)
24	Net weight	Approx. 49 kg
Protection function		
25	Over-voltage protection	System over-voltage, cell over-voltage
26	Under-voltage protection	System under-voltage, cell under-voltage
27	Over-current protection	Charging over-current, discharging over-current
28	Temperature protection	Charging high temperature, charging low temperature, discharging high temperature, discharging low temperature
29	Short circuit protection	BMS hardware protection, external fuse
30	Reverse connection protection	Available, when it is powered off
31	Dielectric withstand test	Available
32	Pre-charge function	Available
33	Equalization function	Available
34	Hibernation function	Available

2 Installation

2.1 Precautions for Installation

- Light intensity is required near the installation location.
- Comply with the safety operation technical regulations when lifting and handling heavy objects.
- Equipment and tools must be complete, intact, and reliable. It is strictly prohibited to use tools with cracks, burrs, loose handles, etc., that do not meet the safety standards.
- Installation operations must be guided by qualified engineers.
- During installation, two people must work together, one operating and the other inspecting.
- The original cable connection and operation process shall not change without the authorization of the company's consent.







2.2 Preparing for Installation



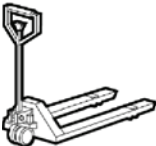

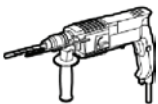

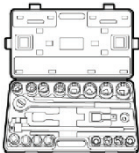

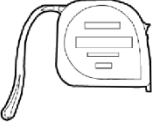

2.2.1 Tools

Insulated installation tools must be used to prevent electric shocks. If tools without insulation protection are used, the exposed metal parts must be wrapped and insulated with insulating tape.

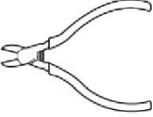
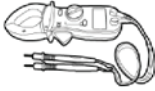
The following table shows tools that need to be prepared before installation.

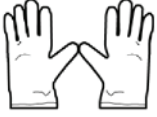
Table 7. Tools

Electric screwdriver	Manual forklift	Electric forklift	Impact drill
			
Levelling instrument	Socket wrench	Phillips screwdriver	Insulated torque wrench
			

Tape measure	Adjustable wrench	Torque wrench	Claw hammer
			
Diagonal pliers	Clamp meter	Multimeter	Anti-static gloves
			
Helmet	Goggle	Insulation shoes	Insulating tape
			

2.2.2 Packing List

Open the package and take out the product, please check the accessories first. The packing list is shown below.

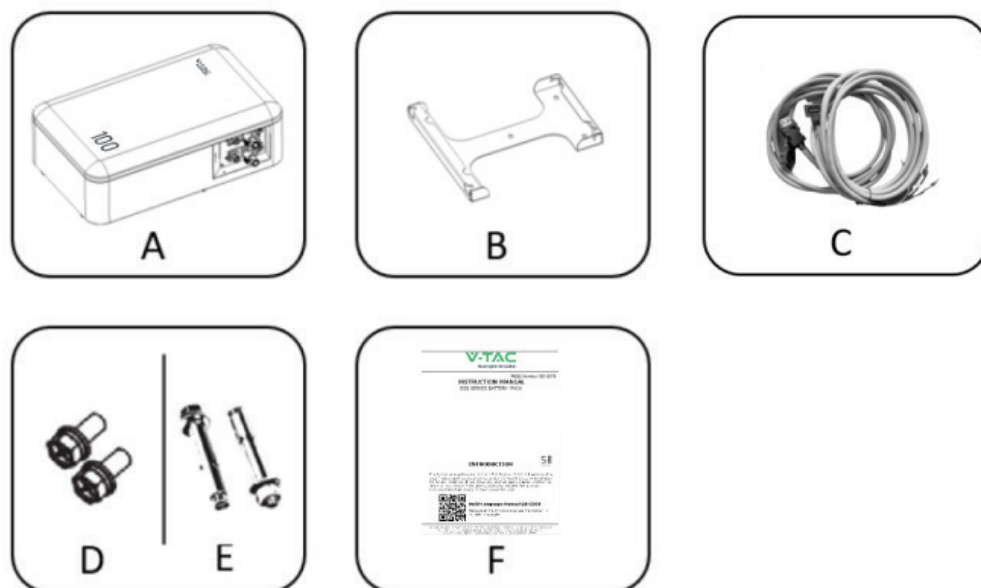

Figure 5. Accessories of V-POWER S05

Item	Description	Quantity
A	Wall-mounted battery module	1
B	Mounting bracket.	1
C	Positive/Negative power cable (<i>*Optional</i>)	2
	Communication cable	1
D	Cross groove outer hexagon combination screw	2
E	Expansion screw	5
F	User manual	1

2.2.3 Unpacking Acceptance

After receiving the goods on-site, please check whether the packing box is intact and inspect the goods in time. If the packing box is slightly damaged, please sign the cargo list to confirm receipt and indicate the extent of the damage. If the damage of the packing box is serious, please refuse to sign.

Please carry out an unpacking inspection after receiving all the goods. If users find that the received goods do not match the packing list, please contact VTAC as soon as possible.

2.3 Installing Guide

Context

Before installing the V-Power S05, users need to plan the installation site. The installation site should comply with the following conditions:

- The installation site should be able to place one V-Power S05, and there should be a wall to mount the inverter. It is recommended that the wall can bear more than 200kg.
- A 500 mm ventilation and operation space should be reserved at the right of the V-Power S05.
- If possible, the installation site should be as spacious and ventilated as possible. If the site is small and confined, please configure auxiliary heat dissipation equipment.

Procedure

- 1 Take out the V-Power S05 and put it in the installation place.



- **The V-Power S05 is heavy. If possible, please use tools to assist in handling and installation.**
-

- 2 Plan the installation site.

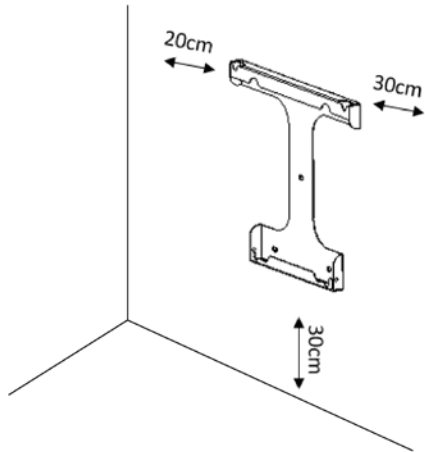

Table 8. Installation Space Requirement

Position	Min. distance
Left-side	200mm
Right-side	300mm
Bottom	300mm

Figure 6. Planning installation site

- 3** Using a drill and level, mount the bracket to the selected wall.

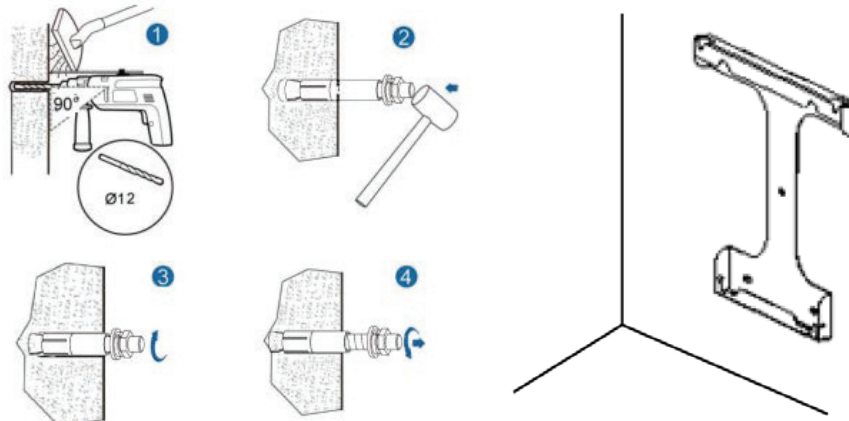

Figure 7. Mounting the bracket

- 4** Check whether the bolt torque of the nuts (4 nuts on the back of V-Power S05) is 8 N.m.

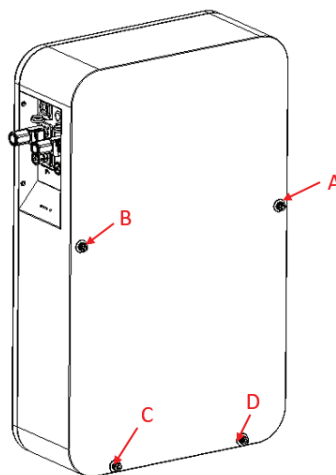

Figure 8. Bolt torque confirmation

- 5 Mount the V-Power S05 on the bracket and fix it with M5 screws on both sides.

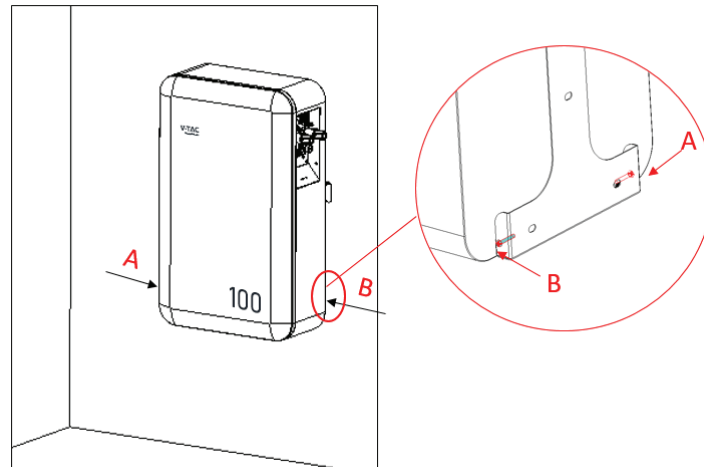

Figure 9. Mounting V-Power S05

- 1 Connect the ground wire to the ground.

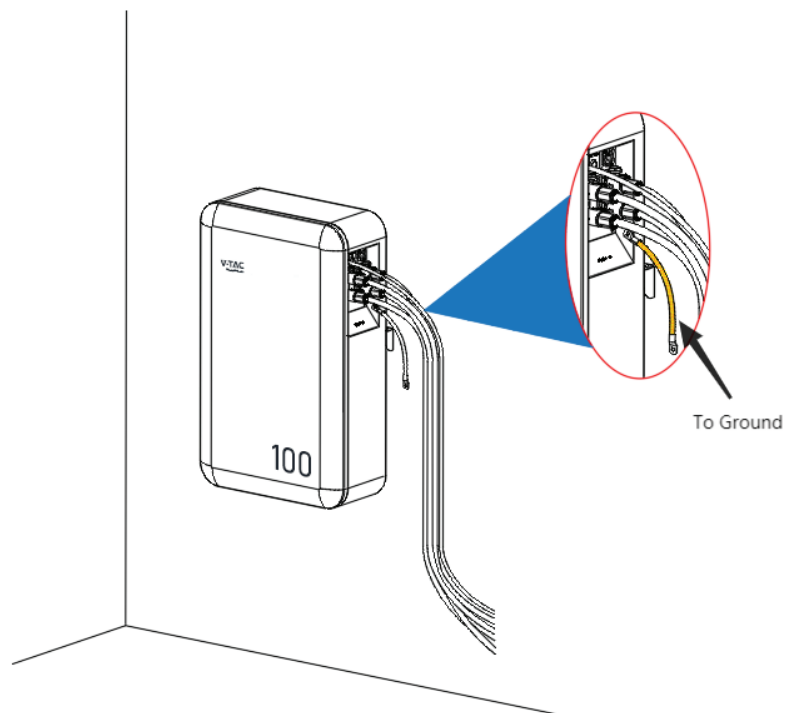

Figure 10. V-Power S05 grounding

2.4 Connecting Power Cable

Context

ATTENTION

1. Insulate installation tools to prevent electric shocks.
2. According to the power value of the inverter used, the number of battery configurations should match the following minimum number of parallel connections:
 - a. When the inverter power $\leq 5\text{kW}$: need to configure at least one VE51100W battery.
 - b. When $5\text{kW} < \text{inverter power} \leq 10\text{kW}$: need to configure at least two VE51100W batteries (connect in parallel).
3. According to the power value of the inverter used, two ways are shown to connect the power cable when batteries are used in parallel:
 - a. When the inverter power $\leq 5\text{kW}$, multiple batteries are used in parallel, connect the power cable base on the Figure 12 wiring method.
 - b. When $5\text{kW} < \text{inverter power} \leq 10\text{kW}$, multiple batteries are used in parallel, a "Junction Box" is required, first connect the power cable of each battery to the Junction Box, then connect the power cable from the Junction Box to the inverter.

The V-Power S05's power cable connection method adopts a self-locking connector. The description of the self-locking connector is shown as follows:

- The steps for connecting the self-locking connector are as follows:
 - A Adjust the direction of the self-locking connector to align with the battery module terminal.
 - B Rotate the self-locking connector slightly, and it will be inserted automatically.
 - C After the self-locking connector is automatically inserted, push it in slightly, and after hearing a click sound, the self-locking connector and the V-Power S05 terminal are connected.
- Need to press the button on the self-locking connector simultaneously when users need to pull out the self-locking connector.



Figure 11. Self-locking connector button

If there are multiple V-Power S05 in parallel, you need to connect the batteries in parallel using the parallel power cables, then connect the power cables to the inverter. Please pay attention to the distinction between battery modules' positive and negative terminals.

Procedure

- 1 Connect the internal power cables of the V-Power S05.

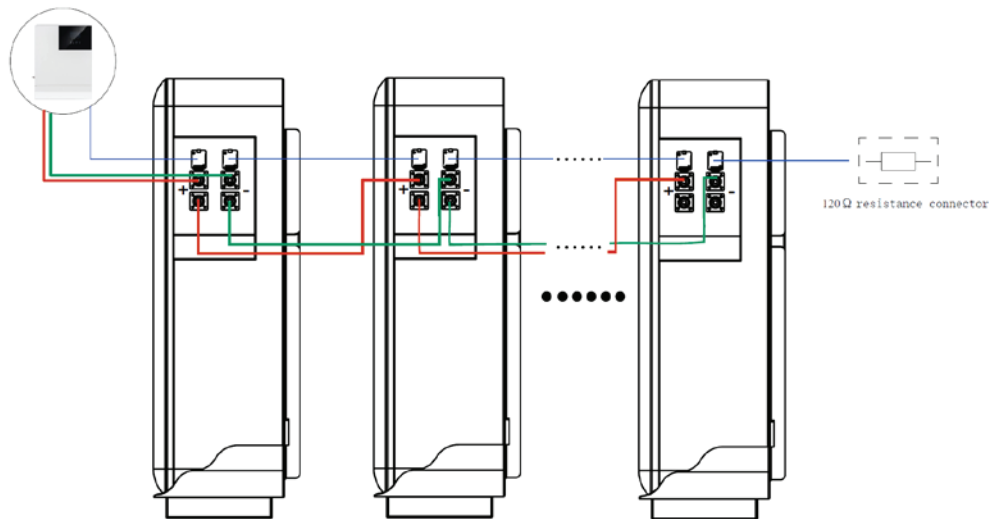

Figure 12. Connect the internal cables

- 6 Connect the P+ & P- power cables to the inverter.

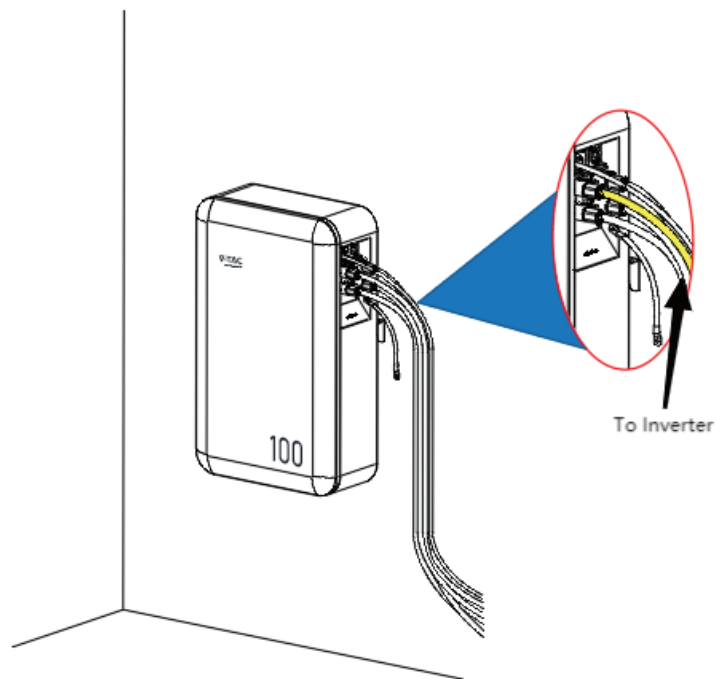

Figure 13. Connect the external cables

NOTE

- The self-locking connector's color should correspond to the battery module terminal's color: orange corresponds to the positive pole, and black corresponds to the negative pole.
- Please take care of the removed battery module protective cover in case of backup.

2.5 Connecting Communication Cable

Context



- Please pay attention to the direction when plugging the communication cable connector, do not operate violently.
- Communication cables and power cables must be routed separately.

If there are multiple V-Power S05 in parallel, you need to connect the communication cables in parallel first. Then you need to connect the communication cable of the inverter to COM1 of any V-Power S05.

Procedure

- 1 Connect the internal communication cables of the V-Power S05.

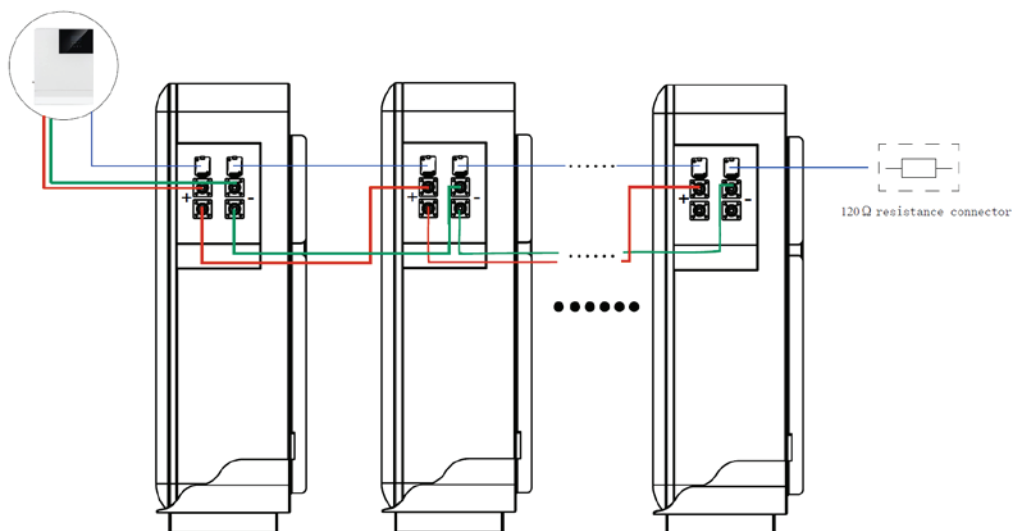

Figure 14. Connect the internal cables

- 7 Connect the remaining power cables and communication cables between the V-Power S05 and inverter.

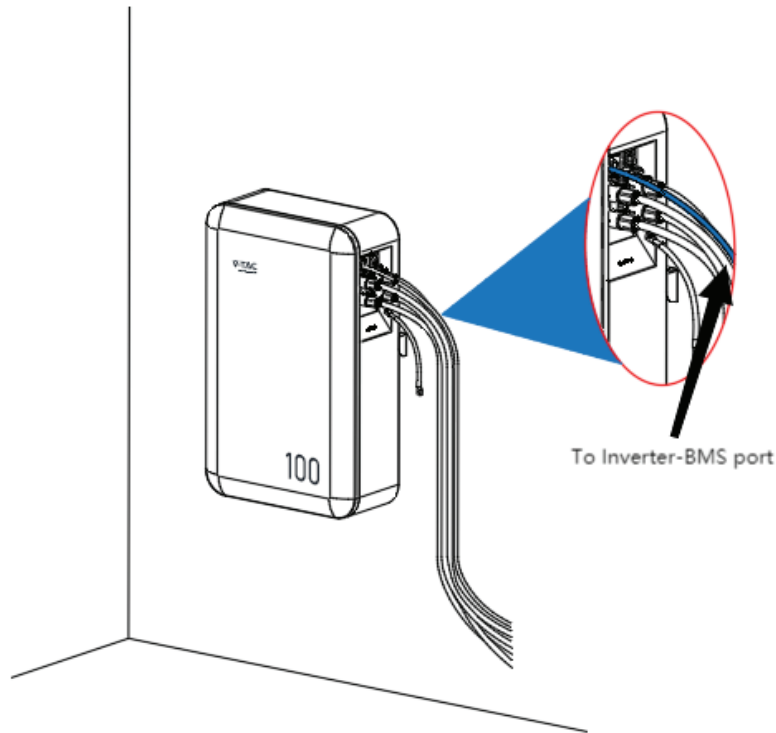

Figure 15. Connect the external cables

- 2** For the wiring diagram of the inverter to the user side, please refer to the inverter user manual.

 **NOTE**

1. Please confirm the usage scenarios of the inverter according to the actual situation. For details, please refer to the user manual of inverter.
 2. The communication cable to the inverter contains L&N cable(220V power supply for BMS). Please connect this cable to the output port of the inverter. (Optional)
 3. Recommended open-circuit current from the battery to the inverter: rated operating current 125A, rated operating voltage \geq DC110V, rated short-circuit breaking capacity \geq 15kA (DC110V). If the inverter has instructions, the inverter shall prevail.
-

3.1 Check before Power-on

Context

After installing the V-POWER S05, users need to perform a pre-power check to ensure that the device installation and cable connection are correct before performing the power-on operation.

Procedure

- 1 Check whether the V-Power S05 sequence is consistent with the layout diagram.
- 2 Check the cable connection on site.
 - Check whether the cables are connected correctly, whether the connectors are firm, and whether the self-locking connector is tightly connected.



- Check whether the communication cable and the power cable are separated.



- 3 Check whether the V-Power S05 are grounded.
- 4 Check the switch status.
 - The DC output switch of the V-Power S05 are open.
 - The DC switch of the inverter is open.
 - The circuit breaker from the inverter to the grid is open.

3.2 Power-on

Context

 **ATTENTION**

1. Before performing the power-on commissioning on the V-Power S05, users must strictly perform the pre-power-on check.
 2. All batteries should have the 50% factory capacity.
-

Prerequisites

Before power on, need ensure that all power cables and communication cables are connected well.

Procedure

Battery power on is divided into three categories: **(1)** One single battery power on (no parallel connection), **(2)** Multiple batteries power on in parallel, **(3)** Batteries expand power on in parallel.

- 1 One single battery power on (no parallel connection):
 - Close the DC switch of inverter;
Close the switch between the inverter and power grid;
Close the circuit breaker between the inverter and battery (if any);
 - Closed ON/OFF switch of battery;
The Run/Alarm indicator should be blinks green.
 - Waiting for the Run/Alarm indicator lights from green flashing into green, means power on normally.
- 2 Multiple batteries power on in parallel:
 - Close the DC switch of inverter;
Close the switch between the inverter and power grid;
Close the circuit breaker between the inverter and battery (if any);
 - First closed the ON/OFF switch in battery that used for the connect communication with inverter, at this time the battery Run/Alarm indicator light should be flash green;
 - Wait for the battery Run/Alarm indicator lights from green flashing into green normally on;
Close the ON/OFF switch of the battery that used for connect communication to the next battery.
 - Repeat the last step, until the last battery Run/Alarm indicator lights from green flashing into green, means power on normally.
- 3 Batteries expand power on in parallel:
 - Power off the original battery and inverter, and connect the newly expanded battery power cable and communication cable in parallel according to 2.4 and 2.5.

- According to the categories (1) or (2), the original battery and inverter to power on first, and make the original battery capacity is above 50%;
- Closed the ON/OFF switch of one new expansion battery, at this time the battery Run/Alarm indicator light should be flash green;
- Wait for the battery Run/Alarm indicator lights from green flashing into green normally on;
Close the ON/OFF switch of the battery that used for connect communication to the next battery.
- Repeat the last step, until the finally battery Run/Alarm indicator lights from green flashing into green, means power on normally.

3.3 Operation Guide

V-Power S05 has completed the system parameter settings at the factory, and the system will run automatically after power is on.

The inverter needs to be set according to actual needs. For detailed operations, please refer to the inverter *User Manual*.

4 Maintenance

ATTENTION

- The engineering personnel who perform the following operations must have received professional training. Before operating and maintaining the V-Power S05, wear anti-static work clothes, anti-static gloves, and wrist straps, and remove conductive objects such as jewelry and watches to avoid electric shock or burns.
- All V-Power S05 internal maintenance work requires insulated tools and should be performed by personnel who have received relevant training.
- When operations such as installation and maintenance only involve the V-Power S05, the output switch of the V-Power S05 should be kept open. When the inverter is involved, the output switch of the V-Power S05, the DC switch of the inverter, and the circuit breaker from the inverter to the grid should be kept open.

4.1 V-Power S05 Storage

- The recommended storage temperature is 15°C~35°C.
- V-Power S05 performance degradation after long-term storage, please shorten shelf time as possible as you can.
- Charge before using to recover capacity loss of self-discharge during storage and transport.
- Storage V-Power S05 should be at 40%-50%SOC when it is not used for a long time.
- Storage batteries over 40°C or under 0°C will reduce battery life. Store the V-Power S05 in a dry and low-temperature, well-ventilated place.

If the V-Power S05 is not used for a long time, it must be charged at regular intervals. The charging requirements are as follows:

Table 9. V-Power S05 Charge Requirement in Storage Status

Storage Temperature	Charge Period	Charge Requirement
20°C~30°C	Every 6 months	1. Charge by 0.2C to 100% SOC
0°C~20°C or 30°C~40°C	Every 3 months	2. Discharge by 0.2C to 0% SOC 3. Charge by 0.2C to 40%~50% SOC

4.2 Monthly Maintenance

Users should conduct a visual inspection of the V-Power S05 monthly. Please refer to the following table for monthly maintenance.

Table 10. Monthly maintenance

Item	Refer Standard	Abnormal Handling Suggestion
Battery appearance	<ul style="list-style-type: none"> ● The appearance is neat and clean without stains. ● The V-Power S05 terminals are intact. ● The V-Power S05 shell is intact, and there are no bumps, breaks, or cracks around it. ● The appearance of battery has no leakage. ● There is no deformation or bulging of the shell. 	<ul style="list-style-type: none"> ● If there is dirt on the surface, clean the V-Power S05's appearance with a cotton cloth. ● If the appearance is damaged, leaking, or deformed, take a photo and replace the defected V-Power S05. ● Please contact VTAC in time for other abnormal situations.
Operation environment	<p>The operation environment is between 0°C-45°C.</p> <p>Operation humidity range: ≤95% RH.</p>	If temperature and humidity are abnormal, check the indoor air conditioner status.

4.3 Quarterly Maintenance

Please refer to the following table for the quarterly maintenance of V-Power S05.

Table 11. Quarterly maintenance

Item	Refer Standard	Abnormal Handling Suggestion
Cable	<p>There is no aging of the connecting cable and no cracking of the insulation layer.</p> <p>The bolts at the cable connection are not loose.</p>	<p>Replace the faulty cable.</p> <p>Fasten the screws.</p>

4.4 Yearly Maintenance

It is recommended to perform trend analysis on recorded data (battery and environment).

4.5 Alarm Handling

Table12. Alarm handling

Phenomenon	Possible failure	Handling method
Red light flashing	Cell or battery under voltage	<p>Check: Ensure that the communication cable between the inverter and battery is properly connected. View the battery data on the inverter display or the inverter APP.</p> <p>Battery voltage\leq44.8 V, or cell voltage\leq2.8 V, battery would generated the under voltage alarm.</p> <p>Battery voltage\geq57.6 V, or cell voltage\geq3.65 V, battery would generated the over voltage alarm.</p> <p>Alarm recover: Under voltage alarm, after the battery turn to charge mode, alarm recover; Over voltage alarm, after the battery turn to discharge mode, alarm recover;</p>
	Cell or ambient temperature over high/low	<p>Check: Ensure that the communication cable between the inverter and battery is properly connected. View the battery data on the inverter display or the inverter APP.</p> <p>If battery temperatures\leq5°C, the battery undertemperature alarm is generated.</p> <p>If Battery temperature \geq45°C, the battery overtemperature alarm is generated.</p> <p>Alarm recover: When the ambient temperature ranges is from 10°Cto 35°C and the cell temperature reach to the normal range, the alarm should be automatically recover.</p>
	Charge or discharge current overhigh	<p>Check: No visual phenomenon. If no abnormal cell voltage and temperature, the over-current alarm should be generated.</p> <p>Alarm recover:</p> <ol style="list-style-type: none"> 1, After the alarm is generated, the current drop and continue for 15 minutes, the alarm should be automatically recover. 2, When the discharge current is too large, by charging (No over-current) can recover the alarm; 3, When the charge current is too large, by discharging (No over-current) can recover the alarm.
Red light on	Battery fault	<p>Check: No visual phenomenon.</p> <p>Alarm recover: Shut down the battery system, wait for 5 minutes, and restart the battery. Check whether the fault can be rectified. If the fault persists, please contact with the technical support engineers.</p>

Acronyms and Abbreviations

AC	Alternating Current
BMU	Battery Management unit
BMS	Battery Management System
BCU	Battery Control Unit
DC	Direct Current
PCU	Protocol Converter Unit
SOC	State of Charge
SOH	State of Health